

Role of endothelial cell extracellular signal-regulated kinase_{1/2} in urokinase-type plasminogen activator upregulation and in vitro angiogenesis by fibroblast growth factor-2

Roberta Giuliani, Maria Bastaki*, Daniela Coltrini and Marco Presta[†]

Unit of General Pathology and Immunology, Department of Biomedical Sciences and Biotechnology, University of Brescia, 25123 Brescia, Italy

*Present address: Department of Cell Biology and Anatomy, School of Medicine, Johns Hopkins University, Baltimore, MD, USA

[†]Author for correspondence (E-mail: presta@med.unibs.it)

Accepted 20 May; published on WWW 7 July 1999

SUMMARY

Downstream signaling triggered by the binding of fibroblast growth factor-2 (FGF2) to its tyrosine-kinase receptors involves the activation of mitogen-activated protein kinase kinase (MEK) with consequent phosphorylation of extracellular signal-regulated kinases (ERKs). Here we demonstrate that FGF2 induces ERK_{1/2} activation in bovine aortic endothelial (BAE) cells and that the continuous presence of the growth factor is required for sustained ERK_{1/2} phosphorylation. This is prevented by the MEK inhibitors PD 098059 and U0126, which also inhibit FGF2-mediated upregulation of urokinase-type plasminogen activator (uPA) and in vitro formation of capillary-like structures in three-dimensional type I collagen gel.

Various FGF2 mutants originated by deletion or substitution of basic amino acid residues in the amino terminus or in the carboxyl terminus of FGF2 retained the capacity to induce a long-lasting activation of ERK_{1/2} in BAE cells. Among them, K₁₂₈Q/R₁₂₉Q-FGF2 was also able to stimulate uPA production and morphogenesis whereas R₁₂₉Q/K₁₃₄Q-FGF2 caused uPA upregulation only. In contrast, K_{27,30}Q/R₃₁Q-FGF2, K₁₂₈Q/K₁₃₈Q-FGF2 and

R_{118,129}Q/K_{119,128}Q-FGF2 exerted a significant uPA-inducing and morphogenic activity in an ERK_{1/2}-dependent manner only in the presence of heparin. Furthermore, no uPA upregulation and morphogenesis was observed in BAE cells treated with the deletion mutant Δ_{27-32} -FGF2 even in the presence of soluble heparin. Thus, mutational analysis of FGF2 dissociates the capacity of the growth factor to induce a persistent activation of ERK_{1/2} from its ability to stimulate uPA upregulation and/or in vitro angiogenesis.

In conclusion, the data indicate that ERK_{1/2} phosphorylation is a key step in the signal transduction pathway switched on by FGF2 in endothelial cells. Nevertheless, a sustained ERK_{1/2} activation is not sufficient to trigger uPA upregulation and morphogenesis. FGF2 mutants may represent useful tools to dissect the signal transduction pathway(s) mediating the complex response elicited by an angiogenic stimulus in endothelial cells.

Key words: Angiogenesis, Endothelium, ERK, FGF, Signaling, Urokinase

INTRODUCTION

Basic fibroblast growth factor (FGF2) belongs to the family of the heparin-binding growth factors (Basilico and Moscatelli, 1992). The single copy human *FGF2* gene encodes multiple FGF2 isoforms with M_r ranging from 24,000 to 18,000 (Florkiewicz and Sommer, 1989). FGF2 isoforms are angiogenic in vivo and induce cell proliferation, protease production and chemotaxis in endothelial cells in vitro (Gualandris et al., 1994). FGF2 stimulates endothelial cells to form capillary-like structures in collagen gels (Montesano et al., 1986) and to invade the amniotic membrane in vitro (Mignatti et al., 1989). Also, the phenotype induced by FGF2 in endothelial cell cultures

includes modulation of integrin expression (Klein et al., 1993), gap-junctional intercellular communication (Pepper and Meda, 1992) and urokinase receptor upregulation (Mignatti et al., 1991). FGF2 exerts its activity on target cells by interacting with specific tyrosine-kinase receptors (FGFRs) and heparan sulfate proteoglycans (HSPGs) of the cell surface (Johnson and Williams, 1993).

Following ligand binding, tyrosine-kinase receptors dimerize and undergo autophosphorylation. Phosphorylated tyrosines serve as docking sites for downstream signal transduction molecules containing either Src-homology 2 or phosphotyrosine-binding domains (Pawson, 1995). Thus, the capacity of growth factors to exert an array of biological responses on the same cell type is thought to reflect the

capacity of different docking transducer proteins to associate with the activated receptor, leading to the switch of multiple intracellular signals (Pawson, 1995). At present, the intracellular signals mediating the complex response of endothelial cells to angiogenic FGF2 remain largely unknown.

Ligand-binding to FGFR1 induces the phosphorylation of extracellular signal-regulated kinases (ERKs) by ERK kinase (MEK) (Mohammadi et al., 1996). Accordingly, ERK activation is required for cell growth induced by FGF2 in fibroblasts and myoblasts (Pages et al., 1993; Milasincic et al., 1996), *uPA* gene upregulation in 3T3 fibroblasts (Besser et al., 1995), and suppression of tumor necrosis factor α -mediated apoptosis (Gardner and Johnson, 1996). Also, ERK activation has been implicated in FGF2-mediated angiogenesis in the chick chorioallantoic membrane (Eliceiri et al., 1998) whereas the antiangiogenic N-terminal fragment of prolactin prevents FGF2-mediated ERK phosphorylation in endothelial cells (D'Angelo et al., 1995). Nevertheless, ERK activation may not be sufficient to trigger a full biological response to FGF2 (Campbell et al., 1995; Bastaki et al., 1997; Dell'Era et al., 1999).

FGF2, M_r 18,000, is a single chain, nonglycosylated 155 amino acid protein (in the present paper the amino acid numbering 1-155 is used for full-length FGF2, even though amino acid numbering 1-146 can be encountered in the scientific literature, where the first residue corresponds to residue Pro-9). The three-dimensional structure of the 146-residue form of human FGF2 has been determined by X-ray crystallography (Zhu et al., 1990; Zhang et al., 1991; Eriksson et al., 1991; Faham et al., 1996). The heparin-binding domain of FGF2 is distinct from its FGFR-binding domain(s) and the formation of FGF2/HSPG/FGFR ternary complexes has been demonstrated (Guimond et al., 1993; Spivak-Krolzman et al., 1994; Rusnati et al., 1994). Thus, heparin interaction may affect the biological activity of FGF2 through different mechanisms including the modulation of its bioavailability, stabilization in the extracellular environment, intracellular fate and access to and dimerization of FGFRs (for a review, see Rusnati and Presta, 1996).

In order to investigate the structure/function relationship of the FGF2 molecule, variants have been developed by deletion or substitution of basic amino acid residues in the amino-terminal and carboxyl-terminal regions of FGF2 (Isacchi et al., 1991; Presta et al., 1992, 1993; Li et al., 1994). The neutralization of these basic residues caused a significant decrease in the urokinase-type plasminogen activator (uPA)-inducing activity of FGF2 without affecting its FGFR-binding capacity and mitogenic activity (Isacchi et al., 1991; Presta et al., 1992, 1993). These data are in keeping with the observation that the mitogenic activity and uPA-inducing capacity of FGF2 are mediated by different signal transduction pathways (Presta et al., 1989; Dell'Era et al., 1999) and that the interaction of FGF2 with FGFR is quantitatively and qualitatively different in mediating mitogenicity and uPA upregulation (Rusnati et al., 1996). Thus, FGF2 variants may represent useful tools to dissect the intracellular signaling activated by an angiogenic factor in endothelial cells.

In the present paper, we have investigated the capacity of

wild-type FGF2 and FGF2 variants to cause ERK_{1/2} phosphorylation, uPA upregulation and in vitro angiogenesis in bovine aortic endothelial (BAE) cells. The results demonstrate that ERK_{1/2} activation is required for uPA upregulation and morphogenesis by FGF2. However, various FGF2 mutants showed a limited capacity to induce uPA activity and/or morphogenesis despite their ability to cause a sustained phosphorylation of ERK_{1/2} in a manner indistinguishable from the wild-type molecule. These data demonstrate the possibility of dissociating FGF2-dependent ERK_{1/2} activation from uPA upregulation and in vitro angiogenesis in endothelial cells by mutational analysis of the growth factor, and suggest that persistent ERK_{1/2} phosphorylation is necessary but not sufficient for mediating these biological responses.

MATERIALS AND METHODS

Materials

Recombinant wild-type human FGF2 and FGF2 mutants were expressed in an *Escherichia coli* type B strain and purified by heparin-Sepharose affinity chromatography (Isacchi et al., 1991; Presta et al., 1992, 1993) with the only exception of recombinant R_{129Q}/K_{134Q} and K_{128Q}/K_{138Q}-FGF2 mutants (Li et al., 1994) that were a gift of A. Seddon (America Cyanamid Company, Pearl River, NY). The molecules were more than 95% pure, as evaluated by reverse-phase HPLC and SDS/PAGE analysis, and cross-reacted with polyclonal anti-FGF2 antibodies. Heparin was obtained from a commercial preparation of unfractionated sodium heparin from beef mucosa (batch 1131/900 from Laboratori Derivati Organici SpA, Milan, Italy). PD 098059, U0126 and SB 210313 were from Calbiochem (San Diego, CA), Promega (Madison, WI) and RBI (Natick, MA), respectively.

Cell cultures

Bovine aortic endothelial cells (provided by A. Vecchi, Istituto Mario Negri, Milan, Italy) were cultured in MEM-Eagle's medium supplemented with 10% fetal calf serum (FCS), 2% essential amino acids and 2% vitamins. Cultures were used between the 6th and the 10th cell passage. CHO cells transfected with the murine FGFR1 cDNA (IIIc variant) were described previously (Rusnati et al., 1996).

¹²⁵I-FGF2 cell binding

FGF2 was iodinated at 800 cpm/fmol as described (Neufeld and Gospodarowicz, 1985). BAE cells were incubated at 4°C in serum-free medium containing increasing concentrations of ¹²⁵I-FGF2, 0.15% gelatin, 20 mM Hepes buffer (pH 7.5). After 2 hours, the amount of ¹²⁵I-FGF2 bound to low- and high-affinity binding sites was evaluated as described (Moscatelli, 1987). Briefly, after a PBS wash, cells were rinsed twice with 2 M NaCl in 20 mM Hepes buffer (pH 7.5) to remove ¹²⁵I-FGF2 bound to HSPGs, and twice with 2 M NaCl in 20 mM sodium acetate (pH 4.0) to remove ¹²⁵I-FGF2 bound to FGFRs. Non-specific binding was measured in the presence of 150 μ g/ml suramin and subtracted from all the values. Binding data were analyzed by Prism software (GraphPad Software, San Diego, CA).

Western blot analysis of ERK_{1/2} phosphorylation

BAE cells were grown to subconfluence in 60 mm dishes. Then, cells were incubated for 30 minutes at 37°C with no addition or with PD 098059, U0126 or SB 210313 before addition of wild-type FGF2. At different times, western blot analysis of the cell extracts was performed as described (Besser et al., 1995) using anti-ERK₂ antibodies (provided by Y. Nagamine, Friedrich Miescher Institute, Basel, Switzerland) or anti-phospho-ERK_{1/2} antibody (New England

Biolabs, Inc., Beverly, MA). In some experiments, BAE cells were treated for different lengths of time with wild-type FGF2 or FGF2 mutant with or without 10 µg/ml heparin and ERK_{1/2} phosphorylation was evaluated as above. Also some cells were treated for 30 minutes with FGF2, added with PD 098059, or washed for 10 minutes with 100 µg/ml suramin (Gualandris and Presta, 1995), and assayed for ERK_{1/2} phosphorylation after 15 minutes.

uPA upregulation assays

Confluent cell cultures were incubated for 18-20 hours in fresh medium containing 0.4% FCS and increasing concentrations of wild-type FGF2 or of FGF2 mutant with or without 10 µg/ml heparin. When specified, cells were incubated for 30 minutes at 37°C with PD 098059, U0126 or SB 210313 before addition of the growth factor. After incubation, cell layers were washed twice with PBS and uPA activity was measured (by absorbance at 405 nm) in the cell extracts (Gualandris and Presta, 1995) by using the plasmin chromogenic substrate H-D-norleucyl-hexahydrotyrosyl-lysine-p-nitroanilide-acetate (American Diagnostic, Greenwich, CT). Human uPA (60,000 U/mg of protein, Calbiochem) was used as a standard. Also, 20 µg samples of cell extracts were separated by 10% SDS-PAGE under non-reducing conditions. Then, zymography for the detection of uPA activity was carried out on a casein/agarose gel as described (Gualandris and Presta, 1995).

Collagen gel assay

For the preparation of three-dimensional gels of reconstituted collagen fibrils, 7 volumes of 1.5 mg/ml rat tail tendon type I collagen (Boehringer Mannheim Italia, Milan, Italy) dissolved in 0.1% acetic acid were mixed on ice with 2 volumes of 5× concentrated medium containing NaHCO₃ and 1 volume of 250 mM Hepes. The pH of the mixture was balanced by alkaline solution containing 1.0 N NaOH and 22 mg/ml NaHCO₃. The mixture was allowed to solidify in 24 well-plates (0.4 ml/well) at 37°C. Then, BAE cells were seeded on the top of collagen gel and allowed to reach confluence. Cell cultures were then treated with FGF2 or FGF2 mutants (10 ng/ml) with or without heparin (10 µg/ml) in the absence or in the presence of PD 098059 (20 µM), U0126 (10 µM) or SB 210313 (10 µM). All treatments were repeated 3 days later. At different times, cells were fixed with 2.5% glutaraldehyde in 0.1 M sodium cacodylate buffer, pH 7.4. The cultures were photographed under a phase-contrast microscope and then the gels were embedded in paraffin. Semithin sections (1 µm) were cut perpendicularly to the culture plane and stained with 1% Toluidine Blue. Experiments were performed in duplicate and repeated at least three times.

RESULTS

ERK_{1/2} activation is required for uPA upregulation and in vitro angiogenesis by FGF2 in BAE cells

Preliminary experiments were performed to characterize the interaction of FGF2 with BAE cells. ¹²⁵I-FGF2 binds to low-affinity HSPGs and high-affinity FGFRs (Moscatelli, 1987). Analysis of the binding data indicates that BAE cells express about 120,000 HSPG sites and 4,000 FGFRs per cell. Northern blot analysis on total RNA isolated from BAE cell cultures demonstrates that these cells express FGFR1 mRNA, whereas FGFR2, FGFR3 and FGFR4 mRNA levels are below the limits of detection of the assay (data not shown).

FGF2 interaction with FGFR1 leads to activation of the Ras/Raf/MEK/ERK signaling pathway (Besser et al., 1995). Accordingly, FGF2 induces a rapid phosphorylation of ERK_{1/2} in BAE cells, detected as a mobility shift of ERK₂ in SDS-

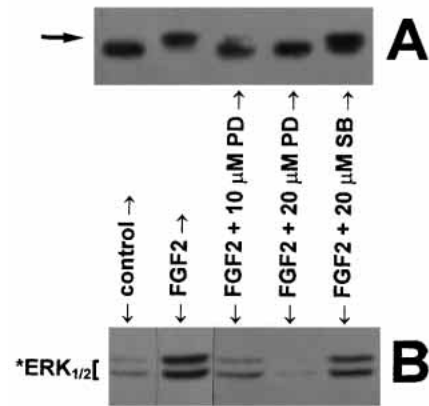

Fig. 1. ERK_{1/2} phosphorylation induced by FGF2 in BAE cells. Cells were incubated for 30 minutes at 37°C without addition, or with 10 µM or 20 µM PD 098059 (PD) or 20 µM SB 210313 (SB), before addition of 30 ng/ml FGF2. After 20 minutes, western blot analysis of the cell extracts was performed using monospecific anti-ERK₂ antibodies (A) or anti-phospho-ERK_{1/2} antibodies (B). In A, phosphorylation of ERK₂ was indicated by a mobility shift on the gel (arrow). *ERK_{1/2}, phosphorylated ERK.

PAGE and by western blot analysis with anti-phospho-ERK_{1/2} antibody (Fig. 1). A 30 minute preincubation of the cells with the MEK inhibitor PD 098059 (Alessi et al., 1995) completely prevents ERK_{1/2} phosphorylation induced by FGF2 (Fig. 1A,B).

As shown in Fig. 2A, ERK_{1/2} phosphorylation is already maximal 30 minutes after treatment with FGF2, remains constant for the next 6 hours, and is still detectable at 14 hours. To assess whether the sustained phosphorylation of ERK_{1/2} requires a persistent stimulation by FGF2, cells were treated with FGF2 for 30 minutes to induce maximal phosphorylation of ERK_{1/2}. Then, PD 098059 was added in the presence of FGF2, or the cells were washed with 100 µg/ml suramin to remove free and receptor-bound FGF2 (Gualandris and Presta, 1995). ERK_{1/2} phosphorylation was assessed 15 minutes thereafter. As shown in Fig. 2B, inhibition of MEK activity by PD 098059 or receptor-displacement of FGF2 by suramin cause a rapid (<15 minutes) dephosphorylation of ERK_{1/2}. These data indicate that a transient stimulation of BAE cells by FGF2 is not sufficient to induce a long-lasting activation of ERK_{1/2}, which depends upon a sustained stimulation of MEK activity consequent to a persistent FGF2-FGFR interaction.

To assess the role of ERK_{1/2} activation in FGF2-mediated uPA upregulation, BAE cells were incubated with FGF2 in the absence or in the presence of PD 098059. As shown in Fig. 3, PD 098059 prevents uPA upregulation by FGF2, as indicated by cell-associated uPA activity assay and SDS-PAGE zymography. In contrast, SB 210313, a selective inhibitor (Cuenda et al., 1995) of the ERK_{1/2}-related mitogen-activated protein kinase p38 (Lin et al., 1995), had no effect on ERK_{1/2} phosphorylation (Fig. 1) and uPA upregulation (Fig. 3).

The capacity of endothelial cells to form capillary-like structures within three-dimensional matrices has been used widely as an in vitro model of angiogenesis (Montesano et al., 1986; Kubota et al., 1988; Gualandris et al., 1996).

Accordingly, confluent BAE cell cultures seeded on a three-dimensional type I collagen gel form numerous hollow capillary-like structures beneath the gel surface when treated with FGF2 (see Fig. 4 and Fig. 8C,F). Furthermore, under these conditions, PD 098059 treatment abolished the morphogenic activity of FGF2 whereas SB 210313 was ineffective (Fig. 4).

Taken together, the data indicate that FGF2/FGFR1 interaction leads to a sustained, MEK-dependent ERK_{1/2} phosphorylation in BAE cells. Activation of this signaling pathway is required to transduce uPA upregulation and morphogenesis by FGF2.

ERK_{1/2} activation and uPA upregulation by FGF2 mutants

Wild-type FGF2 and FGF2 mutants (their schematic structures are shown in Fig. 5) were compared for their capacity to induce ERK_{1/2} activation in BAE cells. All FGF2 mutants cause the rapid phosphorylation of ERK_{1/2}, detected as a mobility shift of ERK₂ (Fig. 6A), and by western blot analysis with anti-phospho-ERK_{1/2} antibody (Fig. 6B). For all mutants, ERK_{1/2} phosphorylation occurs both in the absence and in the presence of soluble heparin (10 µg/ml) in the culture medium. Also, no significant differences were observed in the kinetics of ERK_{1/2} phosphorylation between wild-type FGF2 and mutant

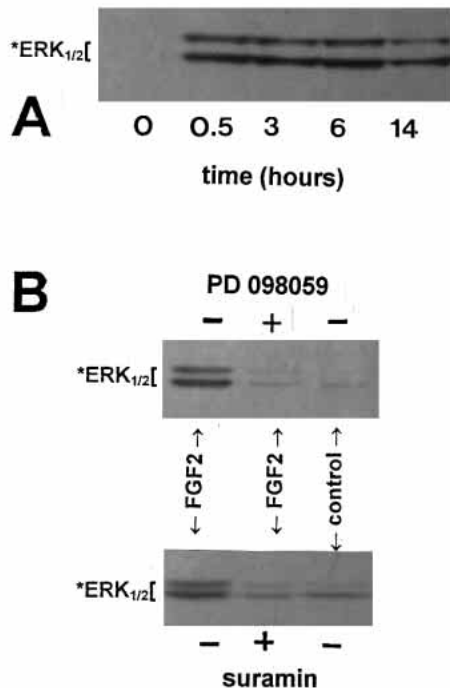

Fig. 2. Kinetics of ERK_{1/2} phosphorylation induced by FGF2. (A) BAE cells were treated with 30 ng/ml FGF2. At the indicated times, cell extracts were probed using anti-phospho-ERK_{1/2} antibodies. (B) BAE cells were incubated without (control) or with 30 ng/ml FGF2 for 30 minutes (FGF2). Then, 20 µM PD 098059 were added to half of the FGF2-treated cell cultures without changing the medium (FGF2+PD 098059) and the other half were washed for 10 minutes at room temperature with 100 µg/ml suramin and then added to fresh medium without FGF2 (FGF2+suramin). Western blot analysis of the cell extracts was performed 15 minutes thereafter using anti-phospho-ERK_{1/2} antibodies. *ERK_{1/2}, phosphorylated ERK.

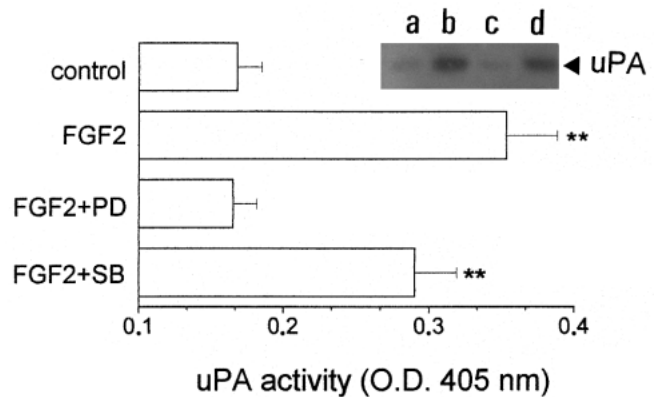

Fig. 3. uPA upregulation by FGF2 requires ERK_{1/2} activation. BAE cells were incubated for 18–20 hours without (control) or with 30 ng/ml FGF2 in the absence (FGF2) or in the presence of 20 µM PD 098059 (FGF2+PD) or SB 210313 (FGF2+SB). uPA activity was then measured by absorbance at 405 nm in the cell extracts, utilizing a chromogenic plasmin substratum. Data are expressed as mean ± s.d. **Significantly different from the control, $P < 0.01$. ($n = 5$). (Inset) SDS-PAGE zymography of BAE cell extracts. (a) Control; (b) FGF2 alone; (c) FGF2+PD 098059; (d) FGF2+SB 210313.

R_{118,129}Q/K_{119,128}Q-FGF2 during the first 24 hours of stimulation (Fig. 6C). Similar results were obtained when the two molecules were tested in the presence of free heparin (data not shown).

In contrast, when the FGF2 mutants were evaluated for their uPA-inducing capacity (Fig. 7A), only R₁₂₉Q/K₁₃₄Q-FGF2 and K₁₂₈Q/R₁₂₉Q-FGF2 were able to upregulate cell-associated uPA activity in BAE cells in a manner similar to

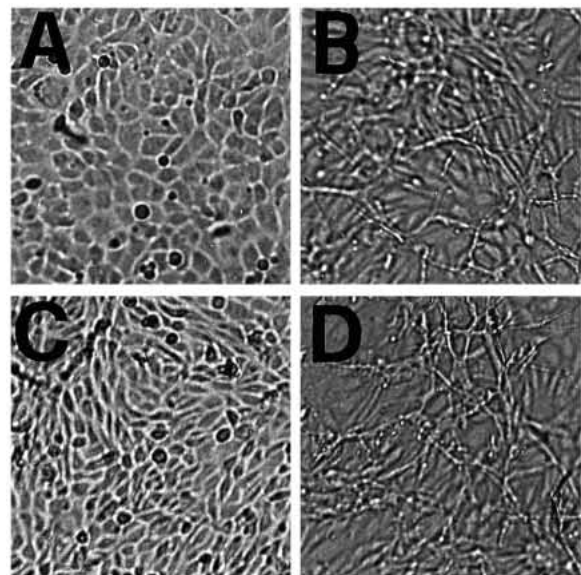

Fig. 4. Angiogenesis in vitro by FGF2 requires ERK_{1/2} activation. BAE cells grown to confluence on type I collagen gel were treated with FGF2 (30 ng/ml) in the absence or in the presence of 20 µM PD 098059 or 10 µM SB 210313. At day 3, cells were fixed and photographed under a phase-contrast microscope. (A) Control; (B) +FGF2; (C) FGF2+PD 098059; (D) FGF2+SB 210313. In B and D, the plane of focus is beneath the cell surface.

Table 1. Morphogenic activity of FGF2 mutants in BAE cells

	Capillary-like tube formation		Morphological phenotype	
	-heparin	+heparin	-heparin	+heparin
Control	–	–	a	a
FGF2	++	++	c	c
Δ_{27-32} -FGF2	–	–	a	a
K _{27,30} Q/R ₃₁ Q-FGF2	–	Rare	b	b/c
K ₁₂₈ Q/R ₁₂₉ Q-FGF2	Rare	++	b/c	c
R _{118,129} Q/K _{119,128} Q-FGF2	–	++	a	c
R ₁₂₉ Q/K ₁₃₄ Q-FGF2	Rare	Rare	b/c	b/c
K ₁₂₈ Q/K ₁₃₈ Q-FGF2	–	Rare	a	b/c

Wild-type FGF2 or FGF2 mutants were added at 10 ng/ml to BAE cell cultures seeded onto three-dimensional type I collagen gel in the absence or in the presence of 10 μ g/ml heparin. All treatments were repeated 3 days later. At day 6, cells were evaluated for the formation of tubular structures.

Morphological phenotypes: a, quiescent monolayer (see Fig. 4A,D); b, activated monolayer (see Fig. 4B,E); c, invasive phenotype (see Fig. 4C,F); b/c, activated monolayer with rare tubular structures.

wild-type FGF2, whereas K_{27,30}Q/R₃₁Q-FGF2, K₁₂₈Q/K₁₃₈Q-FGF2 and R_{118,129}Q/K_{119,128}Q-FGF2 exerted a significant uPA-inducing activity only in the presence of heparin. Moreover, no uPA upregulation was observed in cells treated with Δ_{27-32} -FGF2 either in the absence or in the presence of heparin. These data are in keeping with previous observations on the different capacity of FGF2 mutants to modulate uPA gene transcription in endothelial cells (Gualandris and Presta, 1995).

To assess whether this was restricted to BAE cells, K₁₂₈Q/R₁₂₉Q-FGF2 and R_{118,129}Q/K_{119,128}Q-FGF2 mutants were tested in CHO cells transfected with FGFR1 (Rusnati et al., 1996). Also in this case, R_{118,129}Q/K_{119,128}Q-FGF2 induces uPA upregulation only in the presence of heparin whereas K₁₂₈Q/R₁₂₉Q-FGF2 is equally effective both in the absence and in the presence of the glycosaminoglycan (Fig. 7B).

Taken together, these data demonstrate that various FGF2 mutants have lost the ability to induce uPA upregulation despite their capacity to cause long-lasting ERK_{1/2} activation.

In vitro angiogenesis by FGF2 mutants

When confluent BAE cell cultures were seeded on collagen gel and treated with wild-type FGF2 or FGF2 mutants for 6 days, three highly reproducible morphological phenotypes were observed under the various experimental conditions: (1) the maintenance of a quiescent cobblestone monolayer; (2) the appearance of an activated monolayer characterized by non-invasive, elongated, swirling cells; (3) the induction of an invasive phenotype characterized by the formation of numerous hollow capillary-like structures beneath the gel surface. An intermediate phenotype characterized by an activated monolayer with rare capillary-like structures was also observed under some experimental conditions (see below). The three main phenotypes are shown in Fig. 8, as they appear when the intact gel is observed under a phase-contrast microscope or when semi-thin sections perpendicular to the culture plane are analysed.

As summarized in Table 1, BAE cells grown on collagen gel form tube-like structures in response to wild-type FGF2 (phenotype 'c'). In contrast, the maintenance of a regular cobblestone monolayer is observed for untreated cells or for cells treated with Δ_{27-32} -FGF2, R_{118,129}Q/K_{119,128}Q-FGF2 or K₁₂₈Q/K₁₃₈Q-FGF2 (phenotype 'a'). K_{27,30}Q/R₃₁Q-FGF2 induced instead the formation of an activated monolayer devoid of capillary-like structures (phenotype 'b'), which were present only in very low numbers in cell cultures treated with K₁₂₈Q/R₁₂₉Q-FGF2 or R₁₂₉Q/K₁₃₄Q-FGF2 (intermediate phenotype 'b/c'). Heparin potentiates to a varying extent the morphogenic activity of FGF2 mutants with the exception of Δ_{27-32} -FGF2, which remained inactive, and R₁₂₉Q/K₁₃₄Q-FGF2, which induced the appearance of an intermediate phenotype 'b/c' even in the presence of heparin (Table 1). Thus, the various FGF2 mutants exert a different morphogenic

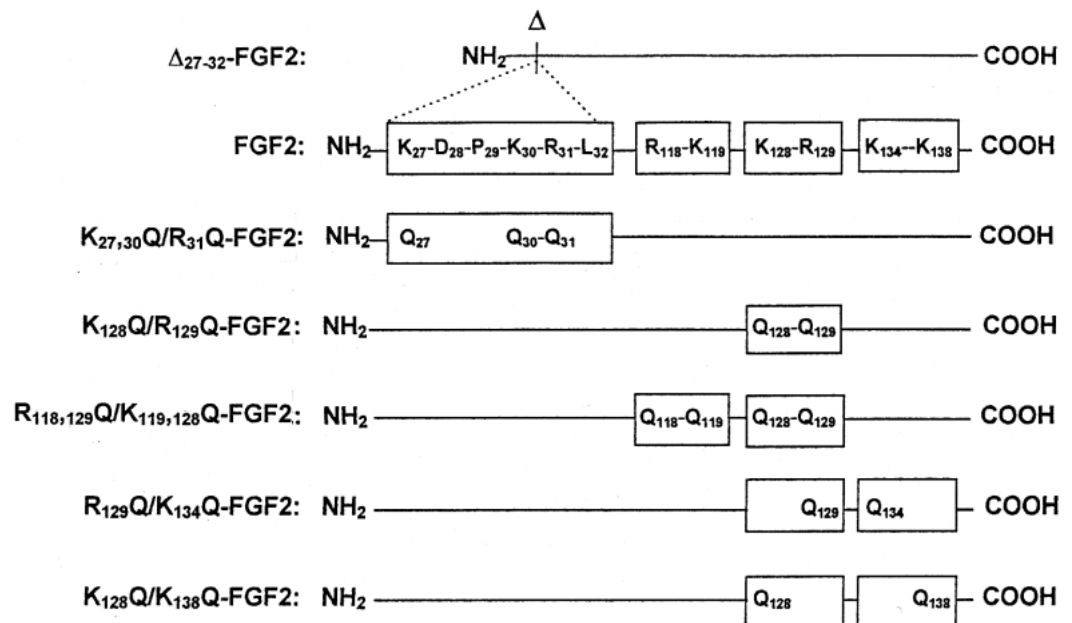

Fig. 5. Schematic representation of the FGF2 mutants utilized in the present study. Mutagenized regions are in boxes and residues are shown in single letter code. Δ , deletion.

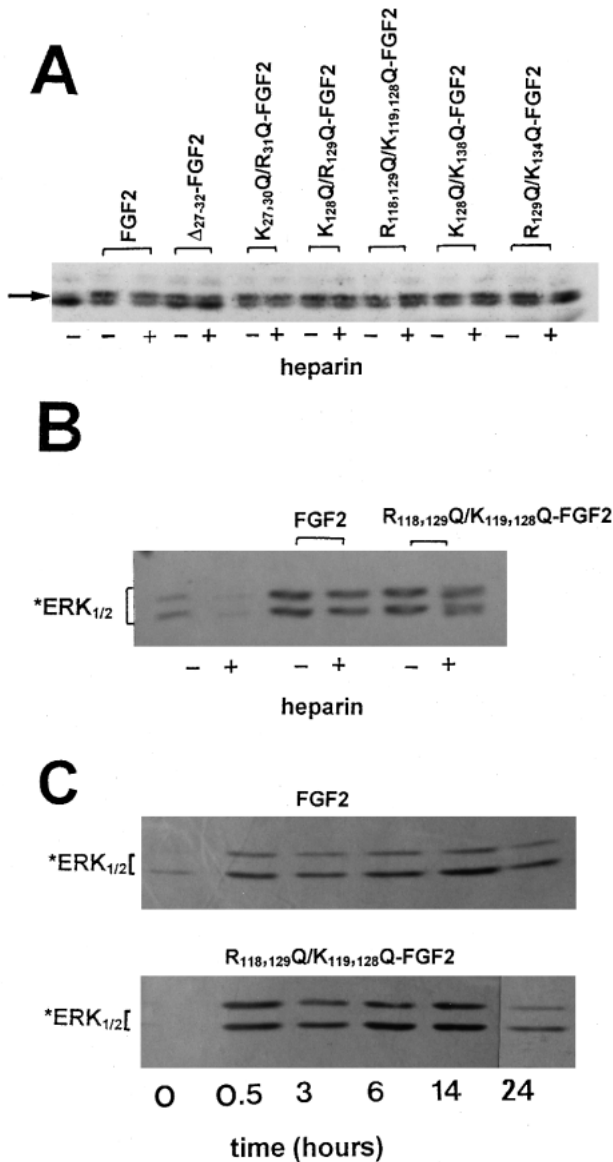

Fig. 6. Sustained ERK_{1/2} phosphorylation induced by FGF2 mutants in BAE cells. (A) Cells were treated for 20 minutes with 10 ng/ml FGF2 or FGF2 mutants with (+) or without (-) 10 μ g/ml heparin. Western blot analysis of the cell extracts was performed using monospecific anti-ERK₂ antibodies and phosphorylation of ERK₂ was indicated by a mobility shift on the gel (arrow). (B) Cells were treated with 10 ng/ml wild-type FGF2 or R_{118,129}Q/K_{119,128}Q-FGF2 with or without 10 μ g/ml heparin. After 20 minutes, western blot analysis of the cell extracts was performed using anti-phospho-ERK_{1/2} antibodies. (C) Cells were treated with 10 ng/ml wild-type FGF2 or R_{118,129}Q/K_{119,128}Q-FGF2. At the indicated times, cell extracts were probed with anti-phospho-ERK_{1/2} antibodies. *ERK_{1/2}, phosphorylated ERK.

activity on BAE cells, which is restored, at least in part, by soluble heparin.

Effect of MEK inhibitor U0126 on ERK_{1/2} activation, uPA upregulation and morphogenesis

To assess whether the morphogenic capacity and uPA-inducing

activity retained by some of the FGF2 mutants tested were still dependent on ERK_{1/2} activation, R_{118,129}Q/K_{119,128}Q-FGF2 plus heparin or wild-type FGF2 were added to BAE cells in the absence or in the presence of the novel MEK inhibitor U0126 (Favata et al., 1998). As shown in Fig. 9, U0126 fully prevents ERK_{1/2} activation, uPA upregulation and morphogenesis induced by wild-type FGF2 and R_{118,129}Q/K_{119,128}Q-FGF2 plus heparin. Identical results were obtained with PD 098059 (data not shown). Again, p38 inhibitor SB 210313 was ineffective (Fig. 9).

DISCUSSION

In the present paper we demonstrate that FGF2/FGFR1 interaction induces a persistent ERK_{1/2} phosphorylation in BAE cells and that the MEK inhibitors PD 098059 and U0126 prevent ERK_{1/2} phosphorylation as well as uPA upregulation and in vitro angiogenesis in FGF2-treated cells. The two inhibitors hamper MEK activity in different ways. PD 098059 prevents the Raf-dependent phosphorylation of the enzyme, whereas U0126 blocks the catalytic activity of activated MEK (Favata et al., 1998). This fact, together with the inability of the protein kinase p38 inhibitor SB 210313 to affect FGF2 activity, strongly indicates that ERK_{1/2} activation by MEK is an essential step in the signal transduction pathway(s) leading to uPA induction and morphogenesis by FGF2 in cultured endothelial cells. Previous observations had implicated ERK activation in FGF signaling (Pages et al., 1993; Milasincic et al., 1996; Besser et al., 1995) and in FGF2-mediated angiogenesis in the chick chorioallantoic membrane (Eliceiri et al., 1998). Interestingly, the antiangiogenic N-terminal fragment of prolactin prevents FGF2-induced ERK phosphorylation in endothelial cells (D'Angelo et al., 1995). Our results emphasize the role of ERK_{1/2} in signal transduction activated by FGFR1 occupancy in endothelium. Nevertheless, we have also observed that different FGF2 mutants derived by neutralization of basic residues located either in the amino-terminal region or in the carboxyl-terminal region of the molecule are characterized by a reduced uPA-inducing activity and/or morphogenic capacity, despite their ability to activate ERK_{1/2} in a manner indistinguishable from the wild-type growth factor. Thus, our data indicate that ERK_{1/2} phosphorylation following FGF2/FGFR1 interaction is necessary but not sufficient for triggering a full biological response in endothelial cells.

These findings are in keeping with the inability of wild-type FGF2 to upregulate uPA activity and to induce fibrin gel invasion in murine aortic endothelial cell cultures even though they respond to the growth factor with a rapid activation of ERK_{1/2} and ³H-thymidine incorporation (Bastaki et al., 1997). Interestingly, the role of ERK activation in FGF2-dependent inhibition of myoblast differentiation has been questioned (discussed in Milasincic et al., 1996). Also, activation of the MEK/ERK cascade plays an important role in insulin-stimulated *c-Fos* induction and mitogenicity but it is not sufficient to induce insulin-dependent metabolic effects such as upregulation of glycogen synthase activity and glucose transport (Denton and Tavaré, 1995).

Previous observations on different cell types have indicated that the duration of ERK_{1/2} phosphorylation dictates the biological consequences of the activation of this signaling

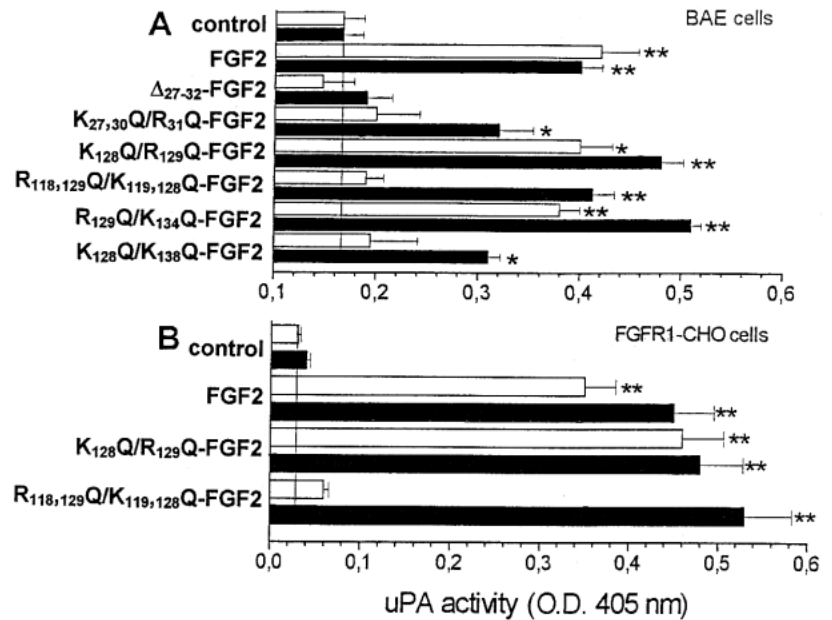

Fig. 7. uPA upregulation induced by FGF2 mutants. BAE cells (A) or FGFR1-transfected CHO cells (B) were treated with FGF2 or FGF2 mutants (10 ng/ml) in the absence (open bars) or in the presence (black bars) of 10 μ g/ml heparin. After 18–20 hours incubation, uPA activity was measured (by absorbance at 405 nm) in the cell extracts utilizing a chromogenic plasmin substratum. Data are expressed as mean \pm s.d. Significantly different from untreated cells (dashed line): *, $P<0.05$; **, $P<0.01$.

pathway. For instance, epidermal growth factor and nerve growth factor bind different tyrosine-kinase receptors in PC12 cells but their intracellular signaling converges to ERK_{1/2} activation. However, nerve growth factor causes a sustained activation of ERK_{1/2} that leads to cell differentiation, whereas the transient ERK_{1/2} activation induced by epidermal growth factor triggers a proliferative signal (for a comprehensive discussion on this point, see Marshall, 1995). Here we have

observed that wild-type FGF2 and various FGF2 mutants induce a persistent activation of ERK_{1/2} in endothelial cells. Depending upon the FGF2 mutant tested, this leads to endothelial cell proliferation, protease production and/or morphogenesis, suggesting that factors other than the kinetics of ERK_{1/2} activation dictate the complex response of endothelial cells to an angiogenic stimulus. Interestingly, recent observations have shown that survival and

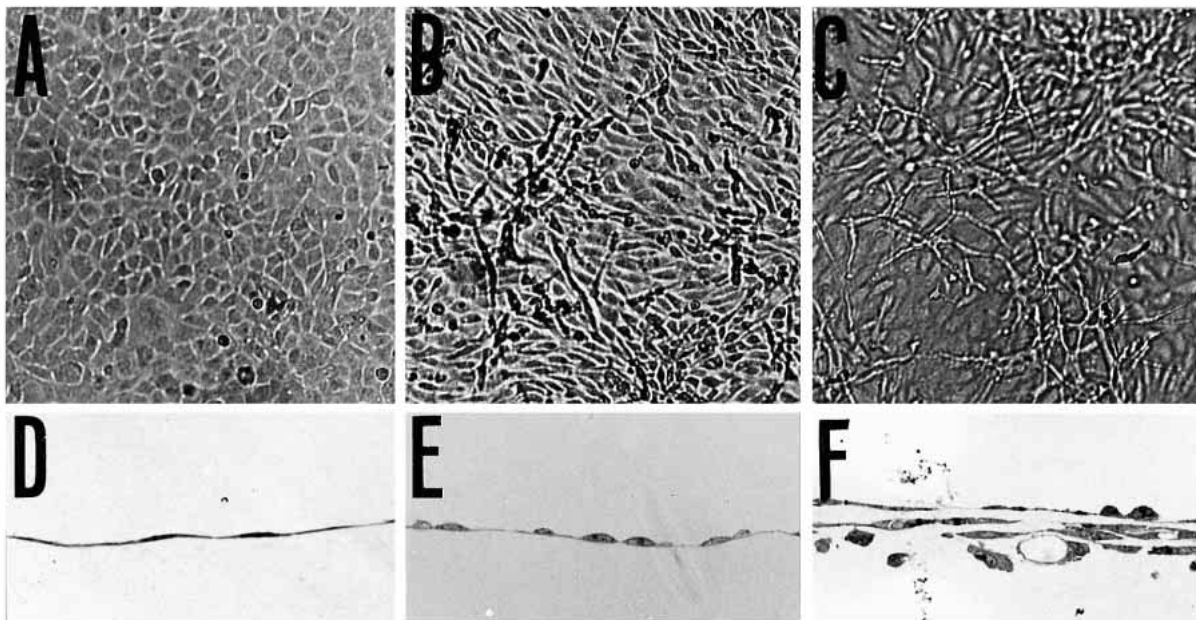

Fig. 8. Morphological phenotypes shown by BAE cells on collagen gel after treatment with FGF2 mutants. BAE cells grown to confluence on type I collagen gel were treated with FGF2 or FGF2 mutants (10 ng/ml) with or without heparin (10 μ g/ml). All treatments were repeated 3 days later. At day 6, cells were fixed, photographed under a phase-contrast microscope (A–C), and then the gels were embedded in paraffin. Semi-thin sections (1 μ m) were cut perpendicular to the culture plane and stained with 1% Toluidine Blue (D–F). (A, D) Quiescent cobblestone monolayer; (B, E) activated monolayer characterized by elongated, swirling cells; (C, F) invasive phenotype characterized by the formation of numerous hollow capillary-like structures beneath the gel surface. In C, the plane of focus is beneath the cell surface. See Table 1 for the correspondence between cell culture treatment and morphological phenotype.

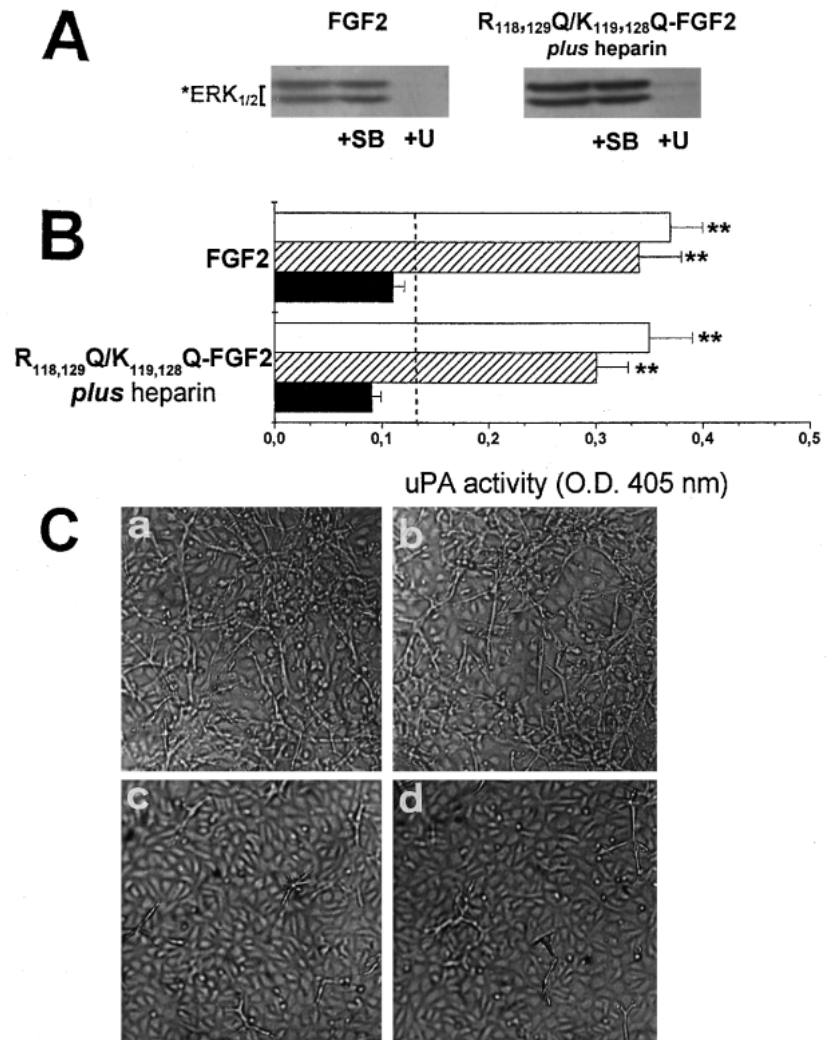

Fig. 9. ERK inhibitor U0126 prevents ERK_{1/2} activation, uPA upregulation and morphogenesis in BAE cells. (A) Cells were incubated for 30 minutes at 37°C with no addition, 20 μM SB 210313 (+SB), or 10 μM U0126 (+U) before addition of 30 ng/ml FGF2 or R_{118,129}Q/K_{119,128}Q-FGF2 plus 10 μg/ml heparin. After 20 minutes, western blot analysis of the cell extracts was performed using anti-phospho-ERK_{1/2} antibodies. *ERK_{1/2}, phosphorylated ERK. (B) Cells were incubated for 30 minutes at 37°C with no addition (open bars), 20 μM SB 210313 (striped bars) or 10 μM U0126 (black bars), before addition of 30 ng/ml FGF2 or R_{118,129}Q/K_{119,128}Q-FGF2 plus 10 μg/ml heparin. After 18–20 hours of incubation at 37°C, uPA activity was measured (by absorbance at 405 nm) in the cell extracts utilizing a chromogenic plasmin substratum. Data are expressed as mean ± s.d. **Significantly different from untreated cells (dashed line), $P < 0.01$. (C) BAE cells grown at confluence on type I collagen gel were treated with 30 ng/ml FGF2 (a,c) or R_{118,129}Q/K_{119,128}Q-FGF2 plus 10 μg/ml heparin (b,d) in the absence (a,b) or in the presence (c,d) of 10 μM U0126. At day 2–3, cells were fixed and photographed under a phase-contrast microscope. The plane of focus is beneath the cell surface.

morphogenesis of human umbilical vein endothelial cells in 3-D collagen gel are modulated by multiple signal transduction pathways, including ERK_{1/2}, phosphoinositide 3-OH kinase and Akt pathways (Ilan et al., 1998). However, we were unable to demonstrate activation of phosphoinositide 3-OH kinase and Akt pathways by FGF2 in BAE cells (R. Giuliani and M. Presta, unpublished observations).

A previous characterization of the biological activity of the FGF2 mutants utilized in the present study indicated that Δ₂₇₋₃₂-FGF2, K_{27,30}Q/R₃₁Q-FGF2 and R_{118,129}Q/K_{119,128}Q-FGF2 are endowed with a normal receptor-binding capacity and mitogenic activity (Isacchi et al., 1991; Presta et al., 1992, 1993). Neutralization of Lys-128/Arg-138 residues diminished the heparin binding capacity of the growth factor and caused a general impairment of its biological activity (Li et al., 1994), while substitution of Lys-128/Arg-129 (Presta et al., 1992) or of Arg-129/Lys-134 (Li et al., 1994) with neutral glutamine residues was ineffective. Our data on the different capacity of these FGF2 mutants to cause ERK_{1/2} activation, uPA upregulation and angiogenesis in vitro emphasize the possibility of dissociating some of the biological activities exerted by FGFs by site-directed mutagenesis of the growth factor (Imamura et al., 1990; Isacchi et al., 1991; Presta et al.,

1992, 1993). Since mutations in different regions of the FGF2 molecule result in similar modifications of its biological activity, alterations of the tertiary structure rather than of the primary structure of the protein seem to be involved in this dissociation. Indeed, the FGF2(27–32) sequence has been implicated in the stabilization of the conformation of the growth factor (Luo et al., 1996). Accordingly, the effect exerted by heparin on the biological activity of some of these FGF mutants may depend on its capacity to stabilize and/or to restore the tertiary structure of FGFs (Gospodarowicz and Cheng, 1986; Saksela et al., 1988; Burgess et al., 1991).

It must be pointed out, however, that two pieces of experimental evidence indicate that the conformation and stability of FGF2 mutants is not grossly altered. (1) Activated ERK_{1/2} is rapidly dephosphorylated when MEK activity is blocked by PD 098059 or when FGF2 is dissociated from FGFR1 by a suramin wash. Therefore, the ability of FGF2 mutants to induce a long-lasting phosphorylation of ERK_{1/2} implies that these mutants retain the capacity to exert a persistent activation of MEK consequent to a sustained stimulation of FGFR1. (2) FGF2 must be present in an active form in the extracellular environment for 12 hours before endothelial cells are committed to proliferate (Presta et al.,

1991) and to produce newly synthesized uPA (Gualandris and Presta, 1995). Nevertheless, the mutants Δ_{27-32} -FGF2, K_{27,30}Q/R₃₁Q-FGF2 and R_{118,129}Q/K_{119,128}Q-FGF2 are endowed with a full mitogenic activity (Isacchi et al., 1991; Presta et al., 1992, 1993) but are devoid of a significant uPA-inducing and morphogenic capacity. Taken together, the data demonstrate that FGF2 mutants are in a conformation suitable to allow a persistent interaction with FGFR1 that triggers a sustained phosphorylation of ERK_{1/2} and cell proliferation, but unsuitable to stimulate uPA production and/or morphogenesis in endothelial cells.

In this respect, our data suggest that the lack of uPA upregulation is not the sole cause of the lack of endothelial cell morphogenesis in BAE cell cultures treated with FGF2 mutants. Indeed, K₁₂₈Q/R₁₂₉Q-FGF2 and R₁₂₉Q/K₁₃₄Q-FGF2 show a very limited capacity to induce capillary-like tube formation, despite their ability to stimulate uPA production.

FGF2/FGFR1 interaction is essential for mediating uPA upregulation but differs both quantitatively and/or qualitatively from the mechanism responsible for the mitogenic activity of the growth factor (Rusnati et al., 1996). Also, results in our laboratory have indicated different FGFR1 tyrosine autophosphorylation requirements for mediating the two biological responses in L6 cells transfected with various FGFR1 mutants (Dell'Era et al., 1999). Previous observations have shown the presence of two receptor binding regions in epidermal growth factor, one responsible for signal transduction and mitogenicity and the other for stabilization of the ligand/receptor interaction (Katsuura and Tanaka, 1989). Also, mutagenesis of glucagon (Unson et al., 1991), hepatocyte growth factor (Lokker et al., 1992), and granulocyte-macrophage colony-stimulating factor (Shanafelt and Kastelein, 1992) can result in the uncoupling of receptor binding and biological activity. Moreover, distinct domains of parathyroid hormone have been demonstrated to be linked to activation of different second messenger pathways (Fujimori et al., 1991). All these observations point to the complexity of the interactions of peptide hormones with their cell membrane receptors and consequent activation of one or more intracellular signaling pathways. On this basis, it seems possible to hypothesize that the FGF2 mutants utilized in the present study may interact differently with FGFR1 and that this interaction, markedly affected by soluble heparin, leads to a partial activation of FGFR1 sufficient to stimulate long-lasting ERK_{1/2} activation and cell growth but not to trigger uPA upregulation and morphogenesis. Further studies on the signaling transduction pathway(s) responsible for the different biological effects exerted by FGF2 in endothelial cells are required to elucidate this point. Site-directed mutagenesis of the FGF2 molecule may represent an useful tool for dissecting the complex response elicited by FGF2 in endothelial cells during angiogenesis.

This work was supported in part by Associazione Italiana per la Ricerca sul Cancro, University of Brescia (Centro per lo Studio del Trattamento dello Scempenso Cardiaco), Ministero Superiore della Sanità (AIDS Project), Ministero Università Ricerca Scientifica e Tecnologica (Cofinanziamento 1997: Project 'Inflammation: Biology and Clinics' and '60%'), Consiglio Nazionale Ricerche (Target Project Biotechnology no. 97.01186.PF49) to M.P. and by European Community (Human Capital Mobility Project 'Mechanisms for the Regulation of Angiogenesis') to M.P. and M.B.

REFERENCES

- Alessi, D. R., Cuenda, A., Cohen, P., Dudley, D. T. and Saltiel, A. R. (1995). PD 098059 is a specific inhibitor of the activation of mitogen-activated protein kinase kinase *in vitro* and *in vivo*. *J. Biol. Chem.* **270**, 27489-27494.
- Basilico, C. and Moscatelli, D. (1992). The FGF family of growth factors and oncogenes. *Adv. Cancer Res.* **59**, 115-165.
- Bastaki, M., Nelli, E. E., Dell'Era, P., Rusnati, M., Molinari-Tosatti, M. P., Parolini, S., Auerbach, R., Ruco, L. P., Possati, L. and Presta, M. (1997). Basic fibroblast growth factor-induced angiogenic phenotype in mouse endothelium. A study of aortic and microvascular endothelial cell lines. *Arterioscler. Thromb. Vasc. Biol.* **17**, 454-464.
- Besser, D., Presta, M. and Nagamine, Y. (1995). Elucidation of a signaling pathway induced by FGF-2 leading to uPA gene expression in NIH 3T3 fibroblasts. *Cell Growth Differ.* **6**, 1009-1017.
- Burgess, W. H., Shaheen, A. M., Hampton, B., Donohue, P. J. and Winkles, J. A. (1991). Structure-function studies of heparin-binding (acidic fibroblast) growth factor-1 using site-directed mutagenesis. *J. Cell. Biochem.* **45**, 131-138.
- Campbell, J. S., Wenderoth, M. P., Hauschka, S. D. and Krebs, E. G. (1995). Differential activation of mitogen-activated protein kinase in response to basic fibroblast growth factor in skeletal muscle cells. *Proc. Natl. Acad. Sci. USA* **92**, 870-874.
- Cuenda, A., Rouse, J., Doza, Y. N., Meier, R., Cohen, P., Gallagher, T. F., Young, P. R. and Lee, J. C. (1995). SB 203580 is a specific inhibitor of a MAP kinase homologue which is stimulated by cellular stresses and interleukin-1. *FEBS Lett.* **364**, 229-233.
- D'Angelo, G., Struman, I., Martial, J. and Weiner, R. I. (1995). Activation of mitogen-activated protein kinases by vascular endothelial growth factor and basic fibroblast growth factor in capillary endothelial cells is inhibited by antiangiogenic factor 16-kDa N-terminal fragment of prolactin. *Proc. Natl. Acad. Sci. USA* **92**, 6374-6378.
- Dell'Era, P., Mohammadi, M. and Presta, M. (1999). Different tyrosine autophosphorylation requirements in fibroblast growth factor receptor-1 mediate urokinase-type plasminogen activator induction and mitogenesis. *Mol. Biol. Cell* **10**, 23-33.
- Denton, R. M. and Tavaré, J. M. (1995). Does mitogen-activated protein kinase have a role in insulin action? The cases for and against. *Eur. J. Biochem.* **227**, 597-611.
- Eliceiri, B. P., Klemke, R., Stromblad, S. and Cheresh, D. A. (1998). Integrin $\alpha\beta 3$ requirement for sustained mitogen-activated protein kinase activity during angiogenesis. *J. Cell Biol.* **140**, 1255-1263.
- Eriksson, A. E., Cousens, L. S., Weaver, L. H. and Matthews, B. W. (1991). Three-dimensional structure of human basic fibroblast growth factor. *Proc. Natl. Acad. Sci. USA* **88**, 3441-3445.
- Faham, S., Hileman, R. E., Fromm, J. R., Linhardt, R. J. and Rees, D. C. (1996). Heparin structure and interactions with basic fibroblast growth factor. *Science* **271**, 1116-1120.
- Favata M. F., Horiuchi, K. Y., Manos, E. J., Daulerio, A. J., Stradley, D. A., Feese, W. S., Van Dyk, D. E., Pitts, W. J., Earl, R. A., Hobbs, F., Copeland, R. A., Magolda, R. L., Scherle, P. A. and Trzaskos, J. M. (1998). Identification of a novel inhibitor of mitogen-activated protein kinase kinase. *J. Biol. Chem.* **273**, 18623-18632.
- Florkiewicz, R. Z. and Sommer, A. (1989). Human basic fibroblast growth factor gene encodes four polypeptides: three initiate translation from non-AUG codons. *Proc. Natl. Acad. Sci. USA* **86**, 3978-3981.
- Fujimori, A., Cheng, S. L., Avioli, L. V. and Civitelli, R. (1991). Dissociation of second messenger activation by parathyroid hormone fragments in osteosarcoma cells. *Endocrinology* **128**, 3032-3039.
- Gardner, A. M. and Johnson, G. L. (1996). Fibroblast growth factor-2 suppression of tumor necrosis factor α -mediated apoptosis requires Ras and the activation of mitogen-activated protein kinase. *J. Biol. Chem.* **271**, 14560-14566.
- Gospodarowicz, D. and Cheng, J. (1986). Heparin protects basic and acidic FGF from inactivation. *J. Cell. Physiol.* **128**, 175-184.
- Gualandris, A. and Presta, M. (1995). Transcriptional and posttranscriptional regulation of urokinase-type plasminogen activator expression in endothelial cells by basic fibroblast growth factor. *J. Cell. Physiol.* **162**, 400-409.
- Gualandris, A., Urbinati, C., Rusnati, M., Ziche, M. and Presta, M. (1994). Interaction of high molecular weight basic fibroblast growth factor (bFGF) with endothelium: biological activity and intracellular fate of human recombinant M_r 24,000 bFGF. *J. Cell. Physiol.* **161**, 149-159.
- Gualandris, A., Rusnati, M., Belleri, M., Nelli, E. E., Bastaki, M., Molinari-Tosatti, M. P., Bonardi, F., Parolini, S., Albini, A., Morbidelli,

- L., Ziche, M., Corallini, A., Possati, L., Vacca, A., Ribatti, D. and Presta, M. (1996). Basic fibroblast growth factor overexpression in endothelial cells: an autocrine mechanism for angiogenesis and angioproliferative diseases. *Cell Growth Differ.* **7**, 147-160.
- Guimond, S., Maccarana, M., Olwin, B. B., Lindahl, U. and Rapraeger, A. C. (1993). Activating and inhibitory heparin sequences for FGF-2 (basic FGF). Distinct requirements for FGF-1, FGF-2, and FGF-4. *J. Biol. Chem.* **268**, 23906-23914.
- Ilan, N., Mahoofi S. and Madri A. (1998). Distinct signal transduction pathways are utilized during the tube formation and survival phases of in vitro angiogenesis. *J. Cell Sci.* **111**, 3621-3631.
- Imamura, T., Engleka, K., Zhan, X., Tokita, Y., Forough, R., Roeder, D., Jackson, A., Maier, J. A. M., Hla, T. and Maciag, T. (1990). Recovery of mitogenic activity of a growth factor mutant with a nuclear translocation sequence. *Science* **249**, 1567-1570.
- Isacchi, A., Statuto, M., Chiesa, R., Bergonzoni, L., Rusnati, M., Sarmientos, P., Ragnotti, G. and Presta, M. (1991). A six-amino acid deletion in basic fibroblast growth factor dissociates its mitogenic activity from its plasminogen activator-inducing capacity. *Proc. Natl. Acad. Sci. USA* **88**, 2628-2632.
- Johnson, D. E. and Williams, L. T. (1993). Structural and functional diversity in FGF receptor multigene family. *Adv. Cancer Res.* **60**, 1-41.
- Katsuura, M. and Tanaka, S. (1989). Topographic analysis of human epidermal growth factor by monospecific antibodies and synthetic peptides. *J. Biochem.* **106**, 87-92.
- Klein, S., Giancotti, F. G., Presta, M., Albelda, S. M., Buck, C. A. and Rifkin, D. B. (1993). Basic fibroblast growth factor modulates integrin expression in microvascular endothelial cells. *Mol. Biol. Cell.* **4**, 973-982.
- Kubota, Y., Kleinman, H. K., Martin, G. R. and Lawley, T. J. (1988). Role of laminin and basement membrane in the morphological differentiation of human endothelial cells into capillary-like structures. *J. Cell Biol.* **107**, 1589-1598.
- Li, L., Safran, M., Aviezer, D., Bohlen, P., Seddon, A. P. and Yayon, A. (1994). Diminished heparin binding of a fibroblast growth factor mutant is associated with reduced receptor binding, mitogenesis, plasminogen activator induction, and in vitro angiogenesis. *Biochemistry* **33**, 10999-11007.
- Lin, A., Minden, A., Martinetto, H., Claret, F. X., Lange-Carter, C., Mercurio, F., Johnson, G. L. and Karin, M. (1995). Identification of a dual specificity kinase that activates the jun kinase and p38-Mpk2. *Science* **268**, 286-290.
- Lokker, N. A., Mark, M. R., Luis, E. A., Bennett, G. L., Robbins, K. A., Baker, J. B. and Godowski, P. J. (1992). Structure-function analysis of hepatocyte growth factor: identification of variants that lack mitogenic activity yet retain high affinity receptor binding. *EMBO J.* **11**, 2503-2510.
- Luo, Y., Gabriel, J. L., Wang, F., Zhan, X., Maciag, T., Kan, M. and McKeehan, W. L. (1996). Molecular modeling and deletion mutagenesis implicate the nuclear translocation sequence in structural integrity of fibroblast growth factor-1. *J. Biol. Chem.* **271**, 26876-26883.
- Marshall, C. J. (1995). Specificity of receptor tyrosine kinase signaling: transient versus sustained extracellular signal-regulated kinase activation. *Cell* **80**, 179-185.
- Mignatti, P., Tauboi, R., Robbins, E. and Rifkin, D. B. (1989). In vitro angiogenesis on the human amniotic membrane: requirement for basic fibroblast growth factor. *J. Cell Biol.* **108**, 671-682.
- Mignatti, P., Mazziari, R. and Rifkin, D. B. (1991). Expression of the urokinase receptor in vascular endothelial cells is stimulated by basic fibroblast growth factor. *J. Cell Biol.* **113**, 1193-1201.
- Milasincic, D. J., Calera, M. R., Farmer, S. R. and Pilch, P. F. (1996). Stimulation of C2C12 myoblast growth by basic fibroblast growth factor and insulin-like growth factor 1 can occur via mitogen-activated protein kinase-dependent and -independent pathways. *Mol. Cell. Biol.* **16**, 5964-5973.
- Mohammadi, M., Dikic, I., Sorokin, A., Burgess, W. H., Jaye, M. and Schlessinger, J. (1996). Identification of six novel autophosphorylation sites on fibroblast growth factor receptor 1 and elucidation of their importance in receptor activation and signal transduction. *Mol. Cell. Biol.* **16**, 977-989.
- Montesano, R., Vassalli, J. D., Baird, A., Guillemin, R. and Orci, L. (1986). Basic fibroblast growth factor induces angiogenesis in vitro. *Proc. Natl. Acad. Sci. USA* **83**, 7297-7301.
- Moscatelli, D. (1987). High and low affinity binding sites for basic fibroblast growth factor on cultured cells: absence of a role for low affinity binding in the stimulation of plasminogen activator production by bovine capillary endothelial cells. *J. Cell. Physiol.* **131**, 123-130.
- Neufeld, G. and Gospodarowicz, D. (1985). The identification and partial characterization of the fibroblast growth factor receptor of baby hamster kidney cells. *J. Biol. Chem.* **260**, 13860-13868.
- Pages, G., Lenormand, P., L'Allemand, G., Chambard, J. C., Meloche, S. and Pouyssegur, J. (1993). Mitogen-activated protein kinases P42^{MAPK} and P44^{MAPK} are required for fibroblast proliferation. *Proc. Natl. Acad. Sci. USA* **90**, 8319-8323.
- Pawson, T. (1995). Protein modules and signalling networks. *Nature* **373**, 573-580.
- Pepper, M. S. and Meda, P. (1992). Basic fibroblast growth factor increases junctional communication and connexin 43 expression in microvascular endothelial cells. *J. Cell. Physiol.* **153**, 196-205.
- Presta, M., Maier, J. A. M. and Ragnotti, G. (1989). The mitogenic signaling pathway but not the plasminogen activator-inducing pathway of basic fibroblast growth factor is mediated through protein kinase C in fetal bovine aortic endothelial cells. *J. Cell Biol.* **109**, 1877-1884.
- Presta, M., Tiberio, L., Rusnati, M., Dell'Era, P. and Ragnotti, G. (1991). Basic fibroblast growth factor requires a long-lasting activation of protein kinase C to induce cell proliferation in transformed fetal bovine aortic endothelial cells. *Mol. Biol. Cell.* **2**, 719-726.
- Presta, M., Statuto, M., Isacchi, A., Caccia, P., Pozzi, A., Gualandris, A., Rusnati, M., Bergonzoni, L. and Sarmientos, P. (1992). Structure-function relationship of basic fibroblast growth factor: site-directed mutagenesis of a putative heparin-binding and receptor-binding region. *Biochem. Biophys. Res. Commun.* **185**, 1098-1107.
- Presta, M., Gualandris, A., Urbinati, C., Rusnati, M., Coltrini, D., Isacchi, A., Caccia, P. and Bergonzoni, L. (1993). Subcellular localization and biological activity of M_r 18,000 basic fibroblast growth factor: site-directed mutagenesis of a putative nuclear translocation sequence. *Growth Factors* **9**, 269-278.
- Rusnati, M. and Presta, M. (1996). Interaction of angiogenic basic fibroblast growth factor with endothelial cell heparan sulfate proteoglycans. Biological implications in neovascularization. *Int. J. Clin. Lab. Res.* **26**, 15-23.
- Rusnati, M., Coltrini, D., Caccia, P., Dell'Era, P., Zoppetti, G., Oreste, P., Valsasina, B. and Presta, M. (1994). Distinct role of 2-O-, N-, and 6-O-sulfate groups of heparin in the formation of the ternary complex with basic fibroblast growth factor and soluble FGF receptor-1. *Biochem. Biophys. Res. Commun.* **203**, 450-458.
- Rusnati, M., Dell'Era, P., Urbinati, C., Tanghetti, E., Massardi, M. L., Nagamine, Y., Monti, E. and Presta, M. (1996). A distinct basic fibroblast growth factor (FGF-2)/FGF receptor interaction distinguishes urokinase-type plasminogen activator induction from mitogenicity in endothelial cells. *Mol. Biol. Cell* **7**, 369-381.
- Saksela, O., Moscatelli, D., Sommer, A. and Rifkin, D. B. (1988). Endothelial cell-derived heparan sulfate binds basic fibroblast growth factor and protects it from proteolytic degradation. *J. Cell Biol.* **107**, 743-751.
- Shanafelt, A. B. and Kastelein, R. A. (1992). High affinity ligand binding is not essential for granulocyte-macrophage colony-stimulating factor receptor activation. *J. Biol. Chem.* **267**, 25466-25472.
- Spivak-Krolzman, T., Lemmon, M. A., Dikic, I., Ladbury, J. E., Pinchasi, D., Huang, J., Jaye, M., Crumley, G., Schlessinger, J. and Lax, I. (1994). Heparin-induced oligomerization of FGF molecules is responsible for FGF receptor dimerization, activation, and cell proliferation. *Cell* **79**, 1015-1024.
- Unson, C. G., Macdonald, D., Ray, K., Durrah, T. L. and Merrifield, R. B. (1991). Position 9 replacement analogs of glucagon uncouple biological activity and receptor binding. *J. Biol. Chem.* **266**, 2763-2766.
- Zhang, J., Cousens, L. S., Barr, P. J. and Sprang, S. R. (1991). Three-dimensional structure of human basic fibroblast growth factor, a structural homologue of interleukin 1 β . *Proc. Natl. Acad. Sci. USA* **88**, 3446-3450.
- Zhu, X., Komiya, H., Chirino, A., Faham, S., Fox, G. M., Arakawa, T., Hsu, B. T. and Rees, D. C. (1990). Three-dimensional structures of acidic and basic fibroblast growth factors. *Science* **251**, 90-93.